



*** Se con il divano acquisti contemporaneamente il secondo rivestimento aggiuntivo, ti costerà la metà (Promo non valida per la finitura Pelle)**
If you buy the second additional cover at the same time with the sofa, it will cost half (Promo not valid for the Leather finish)

Struttura

pannelli di multistrato e massello

Base seduta

cinghie elastiche da 6 e 8 cm incrociate

Sedutapoliuretano D35 IM
MF D40**Schienale**poliuretano D35 IM
MF D40**Cuscino Schienale**

misto piuma d'oca e fibra siliconata

Piede

legno

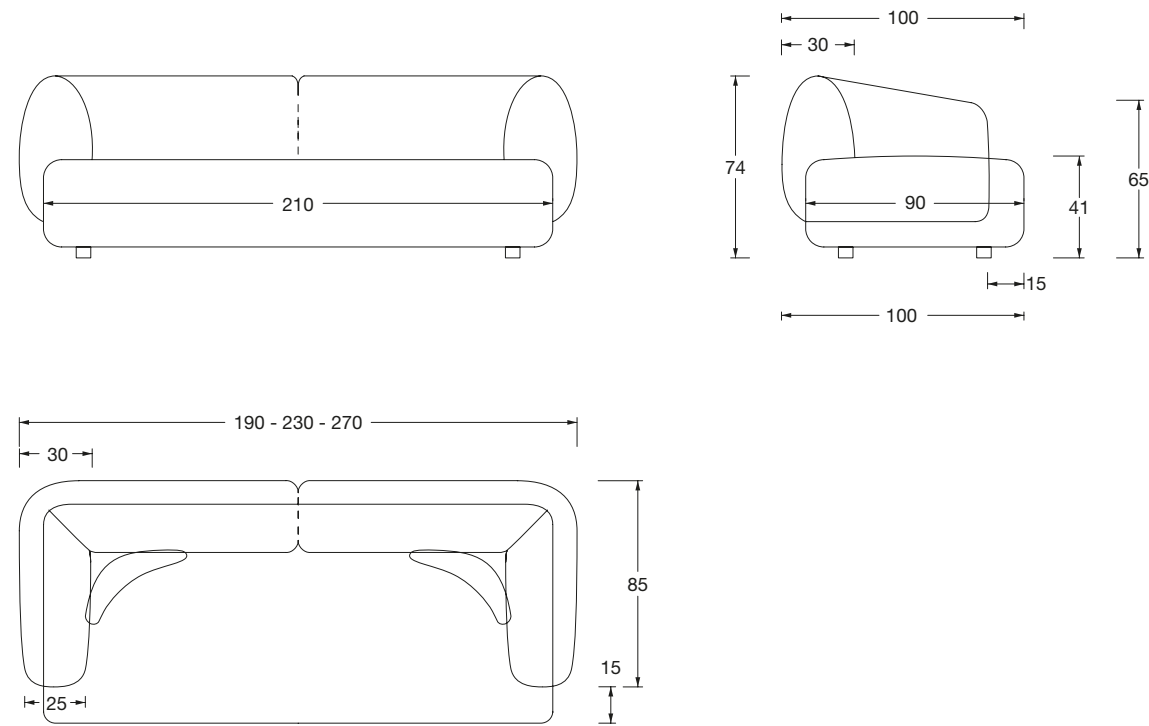
Structure*plywood and solid poplar and fir***Base seat***elastic belts 6/8 cm cross weft***Seat***polyurethane D35 IM
MF D40***Backrest***polyurethane D35 IM
MF D40***Backrest cushion***blend of goose feather and silicone fibre***Feet***wood*

Completamente sfoderabile

Completely removable cover

Divani
Sofas

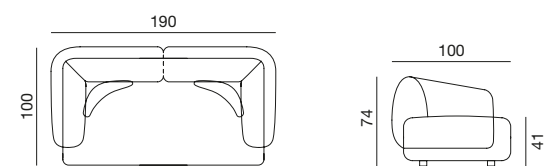

Descrizione Description	Codice Code	Lato Side	Tessuti - Fabrics				Pelle - Pelle			Tessuto cliente L./H. C.O.M. fabric L./H.
			Cat. B	Cat. C/D	Cat. Must	Cat. K	Cat. E	Cat. Plus	Cat. Luxury	
Espanso Foam	357CE1N 190									10,00/1,40
Fodera Cover	C57CE1N 190									10,00/1,40

m³ 1,60 - kg. 83

Divani
Sofas

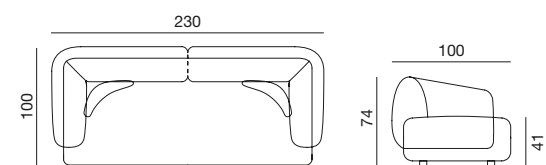

Descrizione Description	Codice Code	Lato Side	Tessuti - Fabrics				Pelle - Pelle			Tessuto cliente L./H. C.O.M. fabric L./H.
			Cat. B	Cat. C/D	Cat. Must	Cat. K	Cat. E	Cat. Plus	Cat. Luxury	
Espanso Foam	357CE1N 230									10,67/1,40
Fodera Cover	C57CE1N 230									10,67/1,40

m³ 1,93 - kg. 89

Divani
Sofas

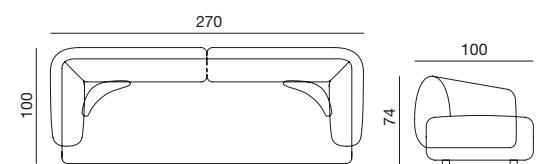

Descrizione Description	Codice Code	Lato Side	Tessuti - Fabrics				Pelle - Pelle			Tessuto cliente L./H. C.O.M. fabric L./H.
			Cat. B	Cat. C/D	Cat. Must	Cat. K	Cat. E	Cat. Plus	Cat. Luxury	
Espanso Foam	357CE1N 270									11,33/1,40
Fodera Cover	C57CE1N 270									11,33/1,40

m³ 2,27 - kg. 97

Laterali
Side element

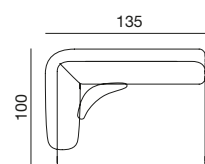

SX / LH

Descrizione Description	Codice Code	Lato Side	Tessuti - Fabrics				Pelle - Pelle			Tessuto cliente L./H. C.O.M. fabric L./H.
			Cat. B	Cat. C/D	Cat. Must	Cat. K	Cat. E	Cat. Plus	Cat. Luxury	
Espanso Foam	357CE2S 135 357CE2R 135	SX / LH DX / RH								5,66/1,40
Fodera Cover	C57CE2S 135 C57CE2R 135	SX / LH DX / RH								5,66/1,40

m³ 1,13 - kg. 50

Laterali
Side element

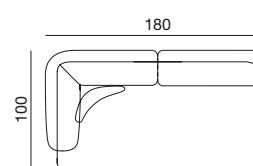

SX / LH

Descrizione Description	Codice Code	Lato Side	Tessuti - Fabrics				Pelle - Pelle			Tessuto cliente L./H. C.O.M. fabric L./H.
			Cat. B	Cat. C/D	Cat. Must	Cat. K	Cat. E	Cat. Plus	Cat. Luxury	
Espanso Foam	357CE2S 180 357CE2R 180	SX / LH DX / RH								8,25/1,40
Fodera Cover	C57CE2S 180 C57CE2R 180	SX / LH DX / RH								8,25/1,40

m³ 1,51 - kg. 81

Laterali
Side element

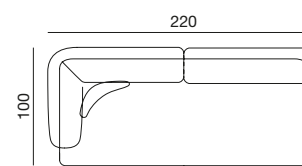

SX / LH

Descrizione Description	Codice Code	Lato Side	Tessuti - Fabrics				Pelle - Pelle			Tessuto cliente L./H. C.O.M. fabric L./H.
			Cat. B	Cat. C/D	Cat. Must	Cat. K	Cat. E	Cat. Plus	Cat. Luxury	
Espanso Foam	357CE2S 220 357CE2R 220	SX / LH DX / RH								9,02/1,40
Fodera Cover	C57CE2S 220 C57CE2R 220	SX / LH DX / RH								9,02/1,40

m³ 1,85 - kg. 87

Laterali
Side element

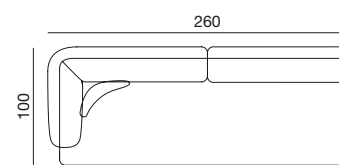

SX / LH

Descrizione Description	Codice Code	Lato Side	Tessuti - Fabrics				Pelle - Pelle			Tessuto cliente L./H. C.O.M. fabric L./H.
			Cat. B	Cat. C/D	Cat. Must	Cat. K	Cat. E	Cat. Plus	Cat. Luxury	
Espanso Foam	357CE2S 260 357CE2R 260	SX / LH DX / RH								9,57/1,40
Fodera Cover	C57CE2S 260 C57CE2R 260	SX / LH DX / RH								9,57/1,40

m³ 2,18 - kg. 95

Centrali
Central elements

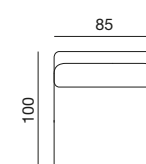

Descrizione Description	Codice Code	Lato Side	Tessuti - Fabrics				Pelle - Pelle			Tessuto cliente L./H. C.O.M. fabric L./H.
			Cat. B	Cat. C/D	Cat. Must	Cat. K	Cat. E	Cat. Plus	Cat. Luxury	
Espanso Foam	357CE3N 085									3,30/1,40
Fodera Cover	C57CE3N 085									3,30/1,40

m³ 0,71 - kg. 36

Centrali
Central elements

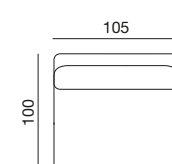

Descrizione Description	Codice Code	Lato Side	Tessuti - Fabrics				Pelle - Pelle			Tessuto cliente L./H. C.O.M. fabric L./H.
			Cat. B	Cat. C/D	Cat. Must	Cat. K	Cat. E	Cat. Plus	Cat. Luxury	
Espanso Foam	357CE3N 105									3,85/1,40
Fodera Cover	C57CE3N 105									3,85/1,40

m³ 0,88 - kg. 40

Centrali
Central elements

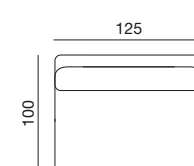

Descrizione Description	Codice Code	Lato Side	Tessuti - Fabrics				Pelle - Pelle			Tessuto cliente L./H. C.O.M. fabric L./H.
			Cat. B	Cat. C/D	Cat. Must	Cat. K	Cat. E	Cat. Plus	Cat. Luxury	
Espanso Foam	357CE3N 125									4,40/1,40
Fodera Cover	C57CE3N 125									4,40/1,40

m³ 1,05 - kg. 44

Angolo
Corner

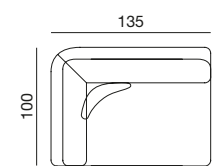

Descrizione Description	Codice Code	Lato Side	Tessuti - Fabrics				Pelle - Pelle			Tessuto cliente L./H. C.O.M. fabric L./H.
			Cat. B	Cat. C/D	Cat. Must	Cat. K	Cat. E	Cat. Plus	Cat. Luxury	
Espanso Foam	357CE4S 135 357CE4R 135	SX / LH DX / RH								6,21/1,40
Fodera Cover	C57CE4S 135 C57CE4R 135	SX / LH DX / RH								6,21/1,40

SX / LH m³ 1,57 - kg. 50

Penisole
Chaise longues

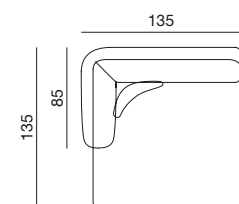

Descrizione Description	Codice Code	Lato Side	Tessuti - Fabrics				Pelle - Pelle			Tessuto cliente L./H. C.O.M. fabric L./H.
			Cat. B	Cat. C/D	Cat. Must	Cat. K	Cat. E	Cat. Plus	Cat. Luxury	
Espanso Foam	357CE5S 135 357CE5R 135	SX / LH DX / RH								7,53/1,40
Fodera Cover	C57CE5S 135 C57CE5R 135	SX / LH DX / RH								7,53/1,40

SX / LH m³ 1,57 - kg. 60

Penisole
Chaise longues

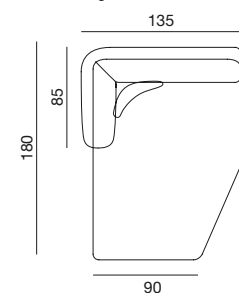

Descrizione Description	Codice Code	Lato Side	Tessuti - Fabrics				Pelle - Pelle			Tessuto cliente L./H. C.O.M. fabric L./H.
			Cat. B	Cat. C/D	Cat. Must	Cat. K	Cat. E	Cat. Plus	Cat. Luxury	
Espanso Foam	357CE5S 180 357CE5R 180	SX / LH DX / RH								7,53/1,40
Fodera Cover	C57CE5S 180 C57CE5R 180	SX / LH DX / RH								7,53/1,40

SX / LH m³ 1,86 - kg. 63

Pouf
Footstool

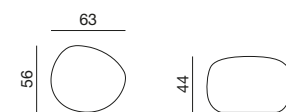

Descrizione Description	Codice Code	Lato Side	Tessuti - Fabrics				Pelle - Pelle			Tessuto cliente L./H. C.O.M. fabric L./H.
			Cat. B	Cat. C/D	Cat. Must	Cat. K	Cat. E	Cat. Plus	Cat. Luxury	
Espanso Foam	357CE8N 056	SX / LH DX / RH								1,32/1,40
Fodera Cover	C57CE8N 056	SX / LH DX / RH								1,32/1,40

m³ 0,16 - kg. 20

Pouf
Footstool

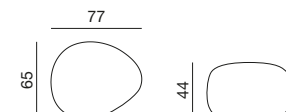

Descrizione Description	Codice Code	Lato Side	Tessuti - Fabrics				Pelle - Pelle			Tessuto cliente L./H. C.O.M. fabric L./H.
			Cat. B	Cat. C/D	Cat. Must	Cat. K	Cat. E	Cat. Plus	Cat. Luxury	
Espanso Foam	357CE8N 065	SX / LH DX / RH								1,76/1,40
Fodera Cover	C57CE8N 065	SX / LH DX / RH								1,76/1,40

m³ 0,22 - kg. 25

Pouf
Footstool

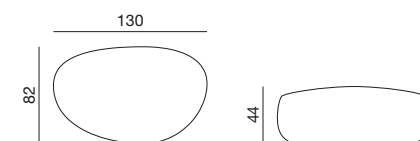

Descrizione Description	Codice Code	Lato Side	Tessuti - Fabrics				Pelle - Pelle			Tessuto cliente L./H. C.O.M. fabric L./H.
			Cat. B	Cat. C/D	Cat. Must	Cat. K	Cat. E	Cat. Plus	Cat. Luxury	
Espanso Foam	357CE8N 082	SX / LH DX / RH								2,42/1,40
Fodera Cover	C57CE8N 082	SX / LH DX / RH								2,42/1,40

m³ 0,36 - kg. 30

Pouf trapezio
Trapeze pouf

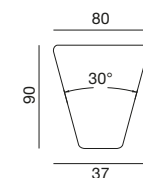

Descrizione Description	Codice Code	Lato Side	Tessuti - Fabrics				Pelle - Pelle			Tessuto cliente L./H. C.O.M. fabric L./H.
			Cat. B	Cat. C/D	Cat. Must	Cat. K	Cat. E	Cat. Plus	Cat. Luxury	
Espanso Foam	357CE4N 090	SX / LH DX / RH								2,20/1,40
Fodera Cover	C57CE4N 090	SX / LH DX / RH								2,20/1,40

m³ 0,45 - kg. 25

Cuscini Kamari
Kamari cushions

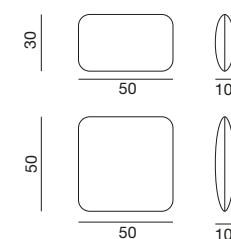

Descrizione Description	Codice Code	Dimensioni Size	Tessuti - Fabrics				Pelle - Pelle			Tessuto cliente L./H. C.O.M. fabric L./H.
			Cat. B	Cat. C/D	Cat. Must	Cat. K	Cat. E	Cat. Plus	Cat. Luxury	
Piuma Feather	357EPCN 030	50x30								0,60/1,40
Piuma Feather	357EPCN 050	50x50								0,60/1,40

m³ 0,01 - kg. 0,6
m³ 0,02 - kg. 0,6

Cuscini Kamari
Kamari cushions

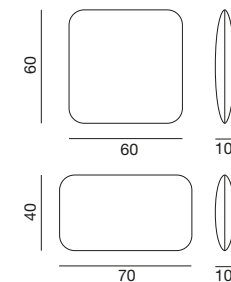

Descrizione Description	Codice Code	Dimensioni Size	Tessuti - Fabrics				Pelle - Pelle			Tessuto cliente L./H. C.O.M. fabric L./H.
			Cat. B	Cat. C/D	Cat. Must	Cat. K	Cat. E	Cat. Plus	Cat. Luxury	
Piuma Feather	357EPCN 060	60x60								0,70/1,40
Piuma Feather	357EPCN 070	70x40								0,70/1,40

m³ 0,04 - kg. 0,6
m³ 0,04 - kg. 0,6

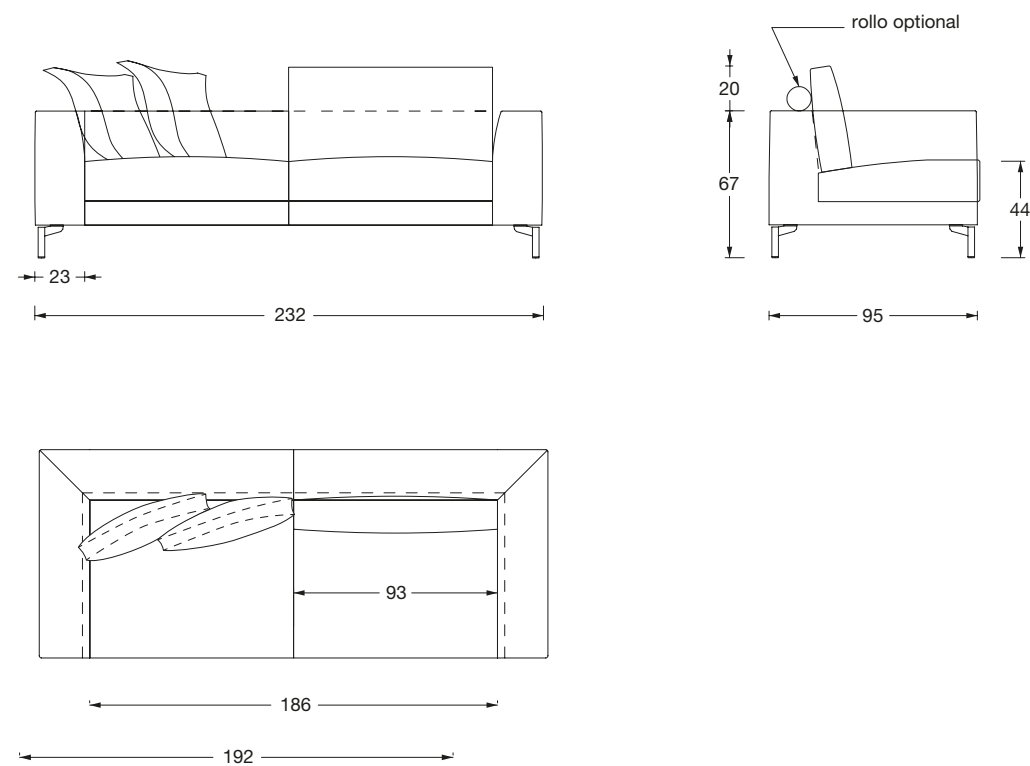
**Base Seduta**

multistrato e massello di pioppo e abete
cinghie elastiche da 6 e 8 cm incrociate
fibra di poliestere pressata

Seduta

misto piuma d'oca
poliuretano D35 IM
poliuretano D25 FR

Schienale

fibra di legno
poliuretano D40 IM
poliuretano D28

Cuscino schienale

misto piuma d'oca e fibra siliconata
tessuto 100% cotone

Bracciolo

fibra di legno
poliuretano D40 IPP
poliuretano D21 IM
fibra di poliestere pressata

Piede

pedi metallo verniciati nero opaco
e Brown Bronze

Completamente sfoderabile

Base seat

plywood and solid poplar and fir
elastic belts 6/8 cm cross weft
pressed polyester fibre

Seat

goose feather blend
polyurethane D35 IM
polyurethane D25 FR

Backrest

wood fibre
polyurethane D40 IM
polyurethane D28

Backrest cushion

blend of goose feather and silicone fibre
100% cotton fabric

Armrest

wood fibre
polyurethane D40 IPP
polyurethane D21 IM
pressed polyester fibre

Feet

metal feet painted black matt
or Brown Bronze

Completely removable cover